

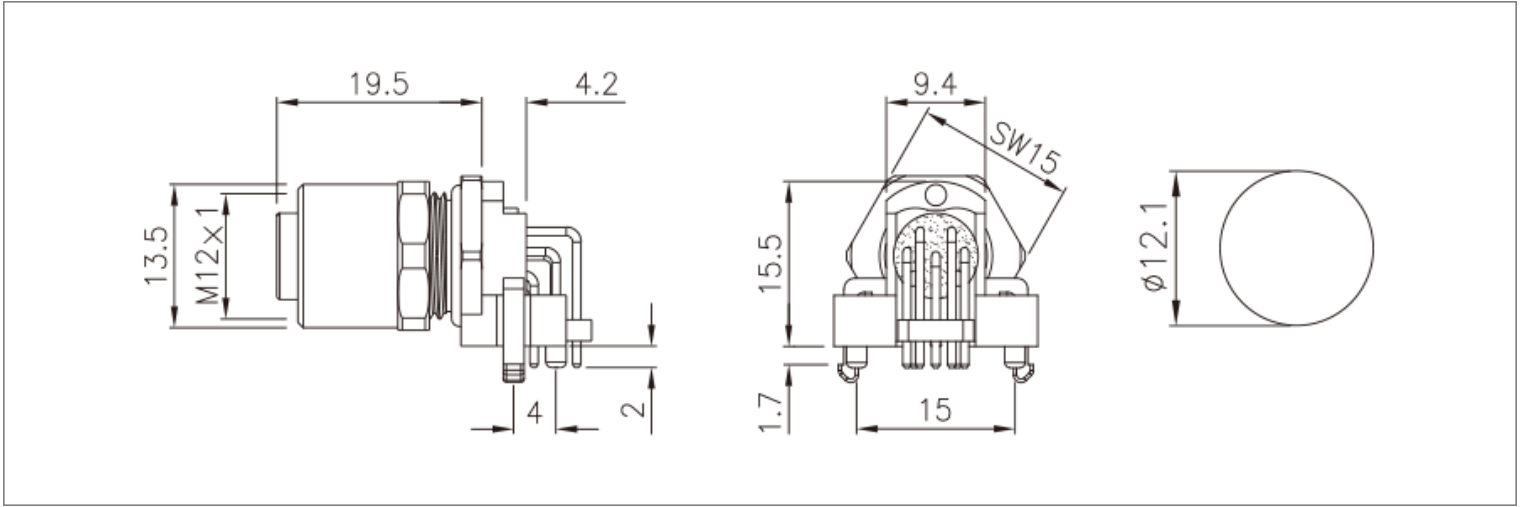



尺寸图







PCB芯位图

芯数	2A	3A	4A	4D	5A
针型 PCB芯位分布图					
	5B	6A	8A	12A	17A
芯数	2A	3A	4A	4D	5A
孔型 PCB芯位分布图					
	5B	6A	8A	12A	17A

接线定义

芯位	线芯颜色	
	2芯	
1	BN	
2	-	
3	BU	

















芯位	线芯颜色	
	3芯	
1	BN	
2	-	
3	BU	
4	BK	

芯位	线芯颜色	
	6芯	
1	BN	
2	WH	
3	BU	
4	BK	
5	-	
6	GY	
7	RD	

芯位	线芯颜色	
	8芯	
1	WH	
2	BN	
3	GN	
4	YE	
5	GY	
6	PK	
7	BU	
8	RD	

芯位	线芯颜色					
	4芯A编码		4芯B编码		4芯D编码	
1	BN		BN		YE	
2	WH		WH		WH	
3	BU		BU		OG	
4	BK		BK		BU	

芯位	线芯颜色	
	12芯	
1	BN	
2	BU	
3	WH	
4	GN	
5	PK	
6	YE	
7	BK	
8	GY	
9	RD	
10	VT	
11	OG	
12	LTGN	

芯位	线芯颜色	
	17芯	
1	BN	
2	BU	
3	WH	
4	GN	
5	PK	
6	YE	
7	BK	
8	GY	
9	RD	
10	VT	
11	OG	
12	LTGN	
13	LTBU	
14	BKWH	
15	BNWH	
16	RDWH	
17	BUWH	

\*接线定义按常规标准，如按协议或者其他请联系我司业务。

电气参数

芯数	针型				额定电流	额定电压		导体规格		孔型			
	A	B	C	D		A/C	D/C	AWG	mm <sup>2</sup>	A	B	C	D
2					4A	250V	250V	22	0.34				
3					4A	250V	250V	22	0.34				
4					4A	250V	250V	22	0.34				
5					4A:A型 B型 2A:C型	60V	60V	22	0.34				
6					2A	30V	30V	24	0.25				
8					2A	30V	30V	24	0.25				
12					1.5A	30V	30V	26	0.14				
17					1.5A	30V	30V	26	0.14				